

**PLEXIGLAS®**

THE ORIGINAL BY RÖHM

INSTRUCTIONS FOR INSTALLING

**PLEXIGLAS®**

Multi-Skin, Corrugated and Solid Sheets





## Contents

Instructions for installing PLEXIGLAS® multi-skin sheets	
Planning .....	4
Supporting structure .....	8
Machining .....	10
Installation .....	14
Cleaning/Material behavior in use .....	18

Instructions for installing PLEXIGLAS® corrugated sheets	
Planning .....	20
Supporting structure .....	22
Machining .....	23
Installation .....	24
Cleaning/Material behavior in use .....	29

Instructions for installing PLEXIGLAS® solid sheets	
Planning .....	30
Supporting structure .....	31
Machining .....	33
Installation .....	35
Cleaning/Material behavior in use .....	41

Glass is known for its weight and fragility. PLEXIGLAS®, on the other hand, is a whole lot tougher. It is lightweight, safe to handle and easy to fabricate. This brochure gives step-by-step instructions for successful installation of PLEXIGLAS® multi-skin and corrugated sheets.

You can find information on the properties and applications of our products in our various publications, including the information brochure on PLEXIGLAS® multi-skin and corrugated sheets, product descriptions, guarantees, etc., which are available on the Internet at [www.plexiglas.de](http://www.plexiglas.de) or from distributors.

When selecting and using our products, you are advised to observe

- the regional building codes
- the applicable standards, e.g. DIN 1055
- the warranty provisions according to VOB (Contracting rules for award of public works contracts) or BGB (German Civil Code)
- the guidelines of the employers' liability insurance association, and so on.

# Creative and contemporary

## Easy to fabricate

PLEXIGLAS® is just as easy to fabricate as wood. Partitions, balcony guards or door infill panels can be designed according to individual wishes.

## 30-year guarantee against yellowing



PLEXIGLAS® always puts you on the safe side. We give a 30-year guarantee that clear-transparent PLEXIGLAS® will not yellow and will retain its high light transmission.

## Lightweight but strong

Even the heaviest sheet in our roofing range weighs less than 6 kg per square meter. That saves effort during installation and reduces the required number of helpers.

## Safety and protection against UV light

Sunburn is a thing of the past with selected grades of PLEXIGLAS® multi-skin and corrugated sheets, which absorb UV light. That has been confirmed by the Hohensteiner Institute in line with the stringent Australian standard AS/NZS 4399:1996.

## Less need for cleaning thanks to AAA

One of the main causes of roof soiling is the growth of algae, mosses etc. But many roofs are difficult to clean because they are hard to reach. Our new generation of PLEXIGLAS® Resist SDP 16 multi-skin sheets has therefore been provided with an anti-algae coating (PLEXIGLAS® Resist AAA) based on nanotechnology. This coating uses the sun's natural UV radiation to make algae, mosses, pollen and other soiling agents lose their grip on the sheet or dissolve completely. The dissolved residue is almost completely washed off by the next rainfall.





# Instructions for installing PLEXIGLAS® multi-skin sheets

## Planning

Careful planning and choosing the right tools, combined with correct storage and fabrication of PLEXIGLAS®, guarantees that you will be satisfied with the overall structure for a long time to come.

### **Tools/auxiliary agents**

The following tools/auxiliary agents are required for installing PLEXIGLAS® multi-skin sheets, depending on the type of project.

- Paint brushes
- White, light-resistant emulsion paint
- Tape measure
- Metal saw
- Rivet pliers/rivets
- Electric drill
- Screws for fastening the base sections
- Circular handsaw with multi-tooth saw blade

And/or

- Conical drill/plastics drill
- Jigsaw with saw blade for 'unplasticized plastics'
- Wire brush
- Compressed air/vacuum cleaner
- Crawling boards or other support to prevent scratching
- Silicone rubber (suitable variants are available from PLEXIGLAS® suppliers)



### Storage

If PLEXIGLAS® multi-skin sheets are not to be installed straight away, they should be stored correctly until used. Make sure the cavities are protected from soiling by suitable end closure sections (inserted at the factory). The same applies to sheets cut on site. If possible, please store the sheets indoors. The PLEXIGLAS® multi-skin sheets are protected against sunlight and moisture during transport by white PE sheeting. Please leave this sheeting in place if the sheets are stored outdoors. The same applies to opened pallets.

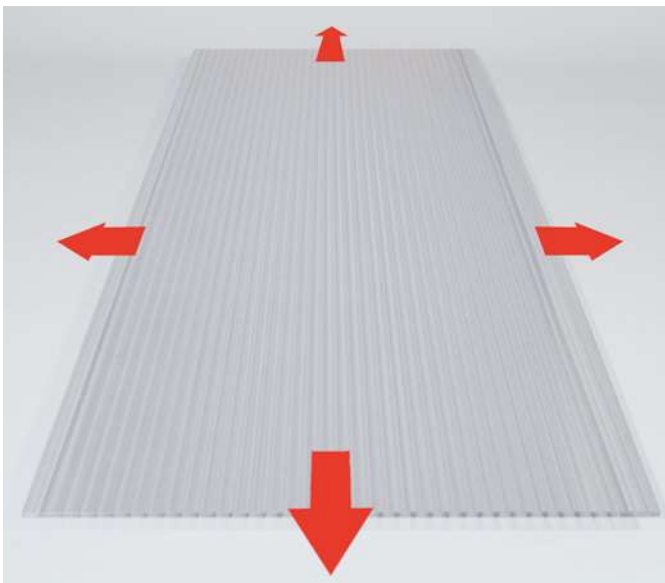

### Allowance for expansion

PLEXIGLAS® multi-skin sheets expand due to heat and moisture. A general allowance is therefore to be made of approx. 5 mm/m for PLEXIGLAS® Alltop SP and of 6 mm/m for PLEXIGLAS® Resist and PLEXIGLAS® Heatstop. The sheets must not be allowed to slip out of the profiles due to shrinkage and must be able to expand freely to exclude damage by buckling.

Suppliers of PLEXIGLAS® multi-skin sheets will be pleased to provide information in this context on the correct choice of glazing systems, help with measurements, etc.



### Color of glazing systems Preventing heat buildup

Glazing systems, especially their upper clamping bars that are exposed to sunlight, should be light-colored (mill-finish aluminium, white uPVC). However, if an additional cover section is used to conceal the screws, this can also be dark because our tests have shown that it will not transfer an excessive level of heat to the clamping system below.

Do not use wide black rubber gaskets!

Dark-colored sealing gaskets only pose no risk of heat buildup if they are no wider than 15 mm. Cover panels that extend over the glazing should also be light in color.

# Installation direction

Many PLEXIGLAS® multi-skin sheets are equipped with an anti-algae coating (AAA) or a water-dispersing NO DROP coating. They show different properties depending which way round they are installed.

## **AAA side facing outwards**

This coating reduces pollen, mosses and algae by means of natural UV radiation. It additionally has a water-dispersing effect (NO DROP effect).

## **AAA side facing inwards**

Facing inwards, the coating has a water-dispersing effect (NO DROP effect) and causes condensation to flow off as a continuous film more or less without droplets.

## **NO DROP side facing outwards**

The coating on the top side has a water-dispersing effect and causes rainwater to flow off as a continuous film more or less without droplets. This provides a better cleaning effect.

## **NO DROP side facing inwards**

Facing inwards, the coating has a water-dispersing effect (NO DROP effect) and causes condensation to flow off as a continuous film more or less without droplets.

The coated side and name of each coating is marked along the edge on the top side of the multi-skin sheets. There is also a corresponding note on the masking film.

On PLEXIGLAS® Alltop sheets, the NO DROP coating is applied to both sides and inside the cavities. The coating has a water-dispersing effect, causing rain and condensation to flow off as a continuous film more or less without droplets. Since the coating is applied to both sides, it makes no difference which side is installed facing inwards or outwards.

For outdoor applications, PLEXIGLAS® multi-skin sheets with a surface texture (C texture) should be installed with the textured side facing downwards. The smooth upper surface keeps the roof clean longer and is much easier to clean.

PLEXIGLAS® Heatstop multi-skin sheets with a coextruded layer on one side should be installed with the coated side facing outwards (to reflect solar heat).

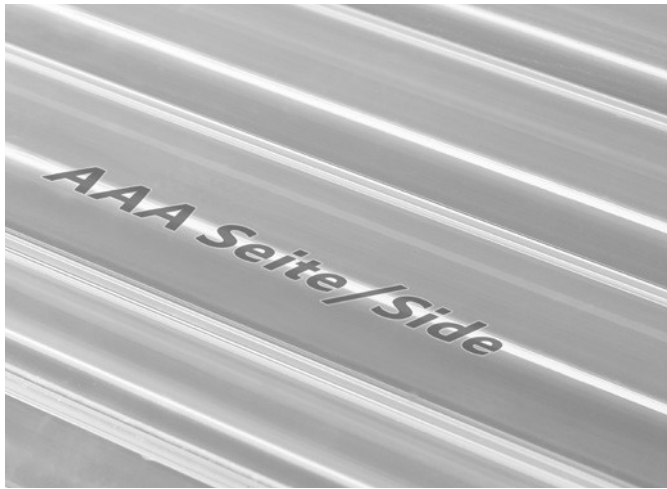

PLEXIGLAS® Resist SDP 16 C- texture

PLEXIGLAS® Heatstop S4P 32 Cool Blue

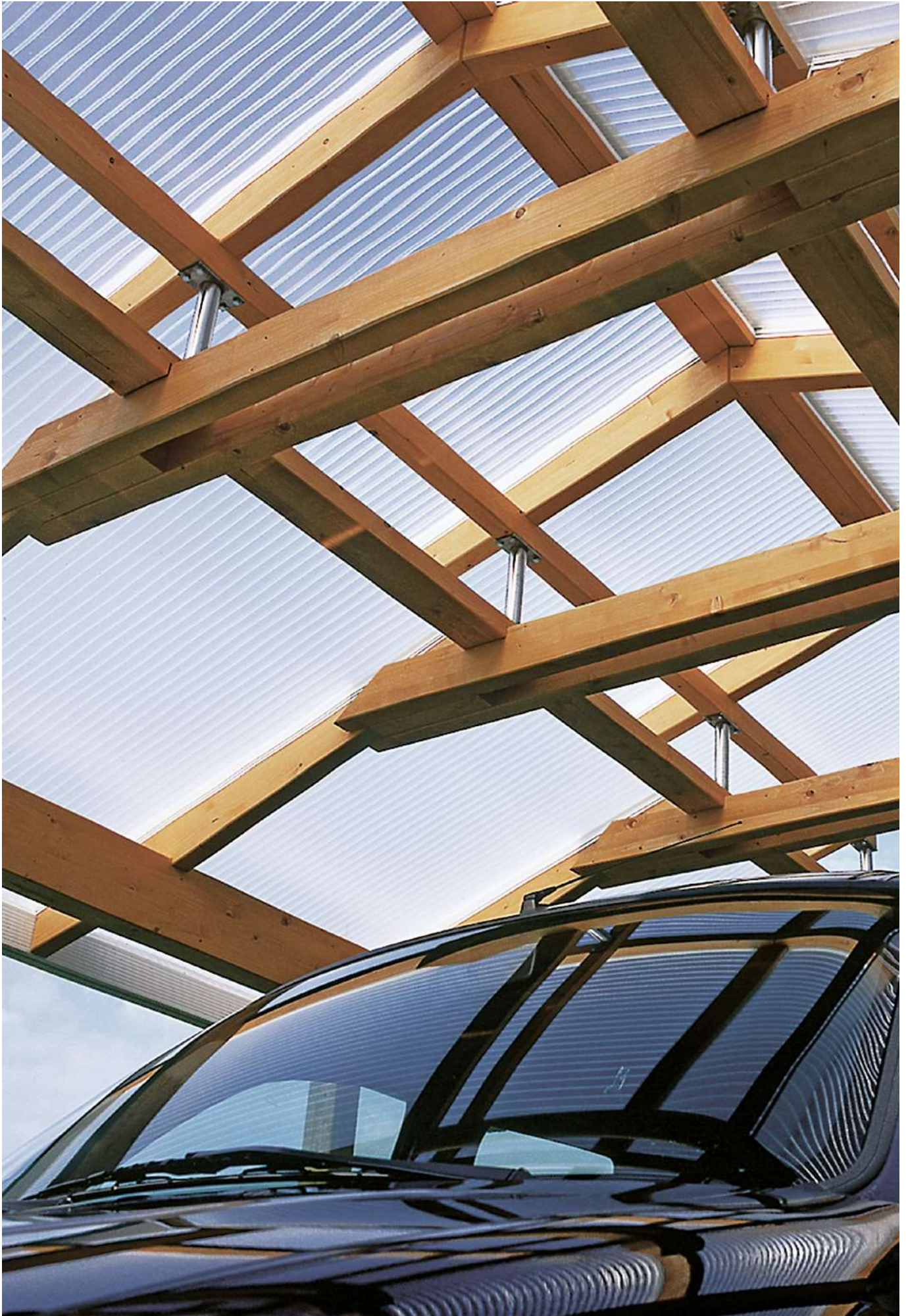

# Supporting structure

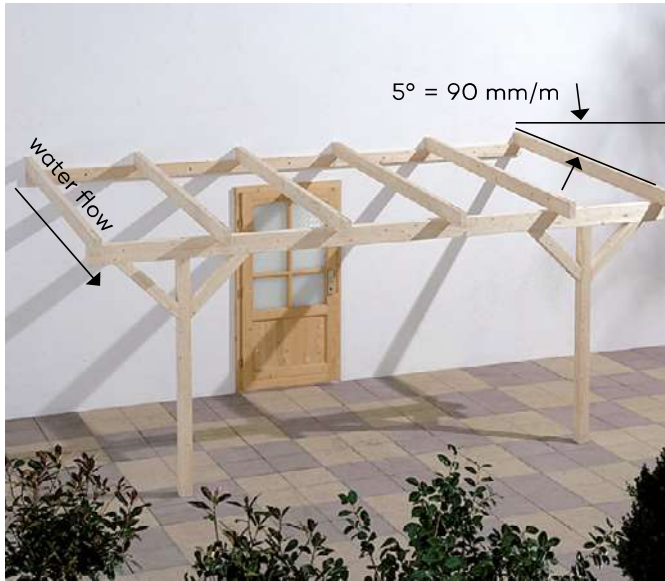

## Roof pitch

Roofs glazed with PLEXIGLAS® multi-skin sheets should have a roof pitch of at least 5° (= 90 mm/m) to allow rainwater to flow off safely. As a general rule, the greater the roof pitch, the better the roof can be cleaned by the rain. Sheets installed as roofing material must be installed with their webs in the direction of the slope, i.e. of the water flow.

Avoid transverse butts and use sheets of roof length wherever possible. Otherwise, design the supporting structure in such a way that two roof sections are obtained that overlap at a distance.



## Material/Preventing heat buildup

The supporting structure should be non-warping and consist of laminated timber beams or metal. Dark surfaces heat up to a greater extent and faster than light-colored surfaces. It is therefore very important to provide all structural surfaces facing the sheets with a durable white or reflective coating (e.g. light-resistant emulsion paint). The heat-protective coating must be allowed to dry properly before installing the sheets. If dark-colored metal structures are used, the surfaces facing the sheets should also be light in color (this can be done by sanding, coating etc.).

Supporting structures treated with wood varnish or paints should be allowed to air for several weeks before installing the multi-skin sheets.



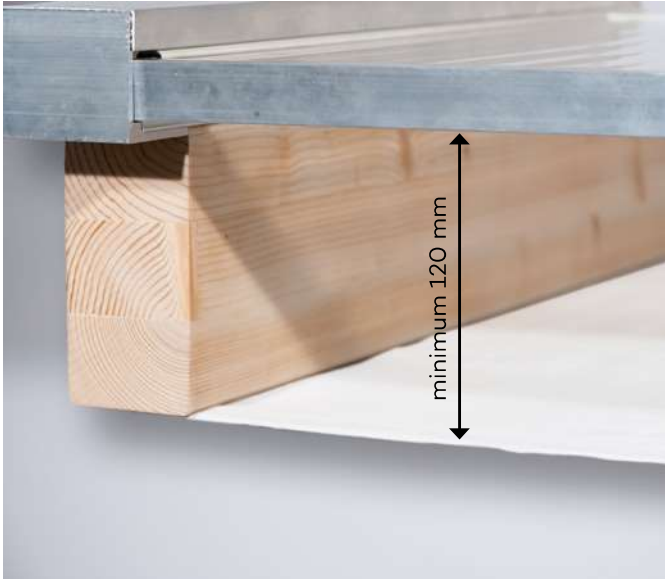

### Interior shading/Preventing heat buildup

Interior shading devices (roller and venetian blinds, curtains etc.) should be white or heat-reflecting and compatible with PLEXIGLAS®.

They should be fixed at a distance of at least 120 mm from the glazing. Avoid wide, box-like closed areas behind/beneath the sheets. These are created by using double flashings or sealing sections above the purlin in the eaves area and may result in crack-inducing heat buildup, even if lined with reflective or white material. Such 'boxes' should therefore be avoided.

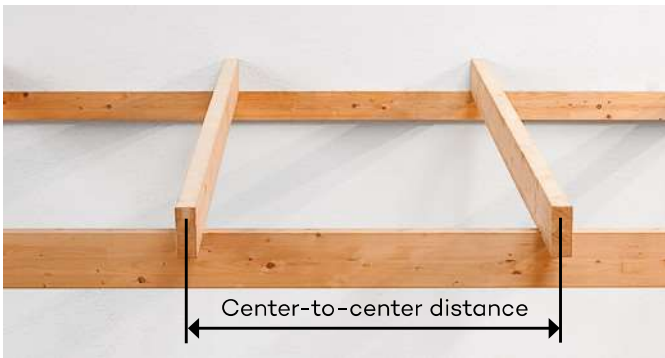

### Support spacing (center-to-center distance)

The center-to-center distance (from the center of one support to the center of the next) provides sufficient allowance for widthwise expansion of the PLEXIGLAS® sheets. It depends on the chosen glazing system and can be ascertained from PLEXIGLAS® suppliers. Typical center-to-center distances are, for example, sheet width + 20 to 30 mm.

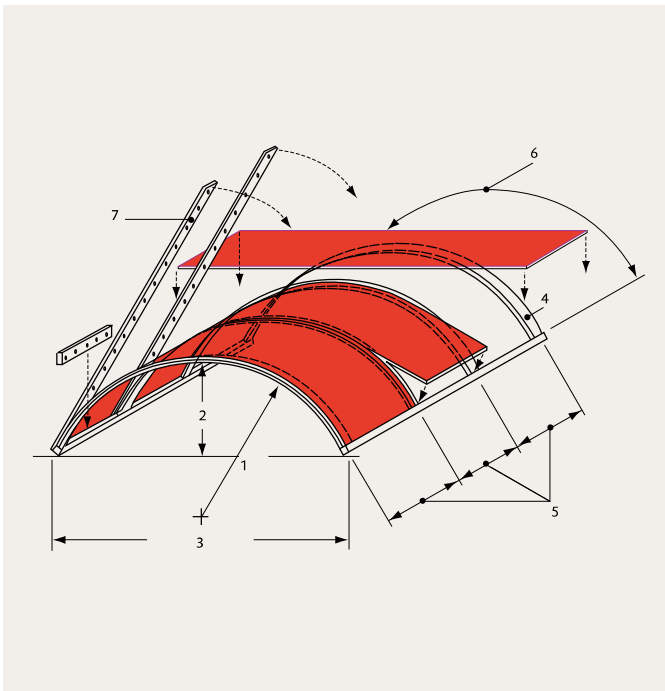

### Barrel vaults

The impact-resistant grades PLEXIGLAS® Resist SDP and PLEXIGLAS® Heatstop SDP can be installed cold-curved, e.g. for barrel vault roofs.

The minimum radius of 150 x sheet thickness must be observed. When calculating the hoop spacing, the expansion and rabbet or clamping depth of at least 15 mm must be borne in mind.

PLEXIGLAS® Alltop multi-skin sheets can only be installed flat.

- 1 = Radius
- 2 = Pitch
- 3 = Span
- 4 = Hoop
- 5 = Hoop spacing
- 6 = Arc length

# Machining

The ease and almost unlimited variety of options with which PLEXIGLAS® can be machined are among its main advantages as compared with many other transparent materials. Using the correct tools is essential for successful work

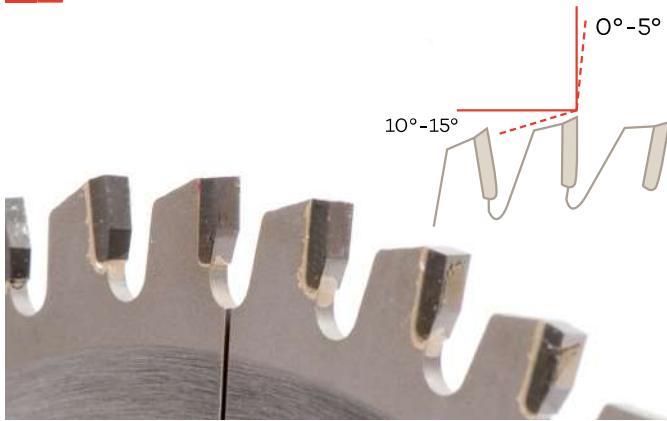

## Cutting to size

High-speed circular (hand)saws with unset, multi-tooth carbide-tipped blades are most suitable for cutting PLEXIGLAS® multi-skin sheets to size. We advise against the use of cutting disks to avoid possible damage to the sheets.



## Marking

Marking should be done on the masking film, which should be left on the sheet while working on it and until it has been installed.

The multi-skin sheets should be secured against flutter. It is best to work with a stop, such as a wooden bar, to prevent the saw from tilting and causing an accident or damaging the cut edge of the sheet.

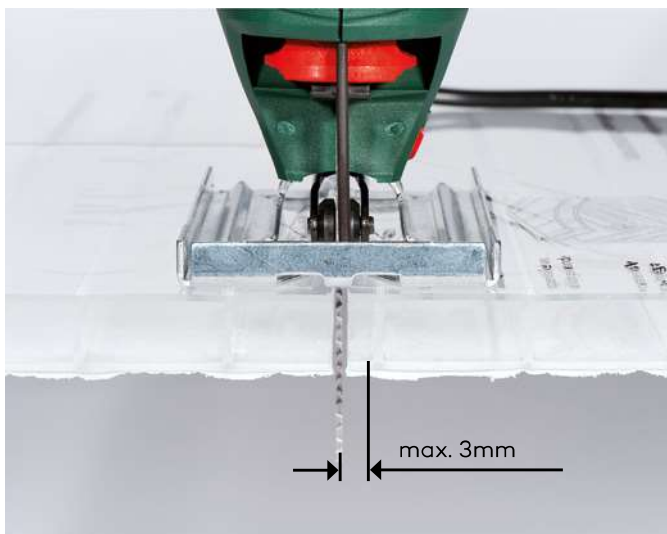

## Reducing the sheet width

If the width of PLEXIGLAS® multi-skin sheets needs to be reduced, the cut edge should be 3 mm at most from the last web to ensure the clamping action of the glazing bar.



### **Reducing the sheet width, reinforcing the open edge**

If the skin of a cut-to-size sheet of PLEXIGLAS® SDP 16 sheets is to protrude more than 15 mm beyond the last web, a PVC section (compatible with PLEXIGLAS®) such as INFILL SECTION 16 should be inserted to reinforce the edge. This ensures that the edge of the multi-skin sheet can be correctly installed in the glazing bar.



### **Drilling**

If drill holes are required, e.g. for cutting out corners, use twist drills with special bits for acrylic (which “scrape rather than cut”), conical or step drills.



### **Corner cut-outs**

If a corner needs to be cut out (e.g. to accommodate pipes, vents etc.), a hole should be drilled in the sheet at the point where the cuts intersect. To cut out corners, drill the hole first at the corner and then cut to it from the sheet edge, using a fine-toothed jig saw without pendulum stroke.

It is essential to perform machining under clean conditions. No one wants to see swarf when they look up at the finished roof. Once the sheet has been installed, it takes a lot of effort to remove such swarf.



#### **Cleaning the cut edges**

Any swarf clinging to the cut edges can be removed using a wire brush.



#### **Removing swarf**

Swarf that has entered the cavities of the multi-skin sheets can be removed with compressed air or a vacuum cleaner.

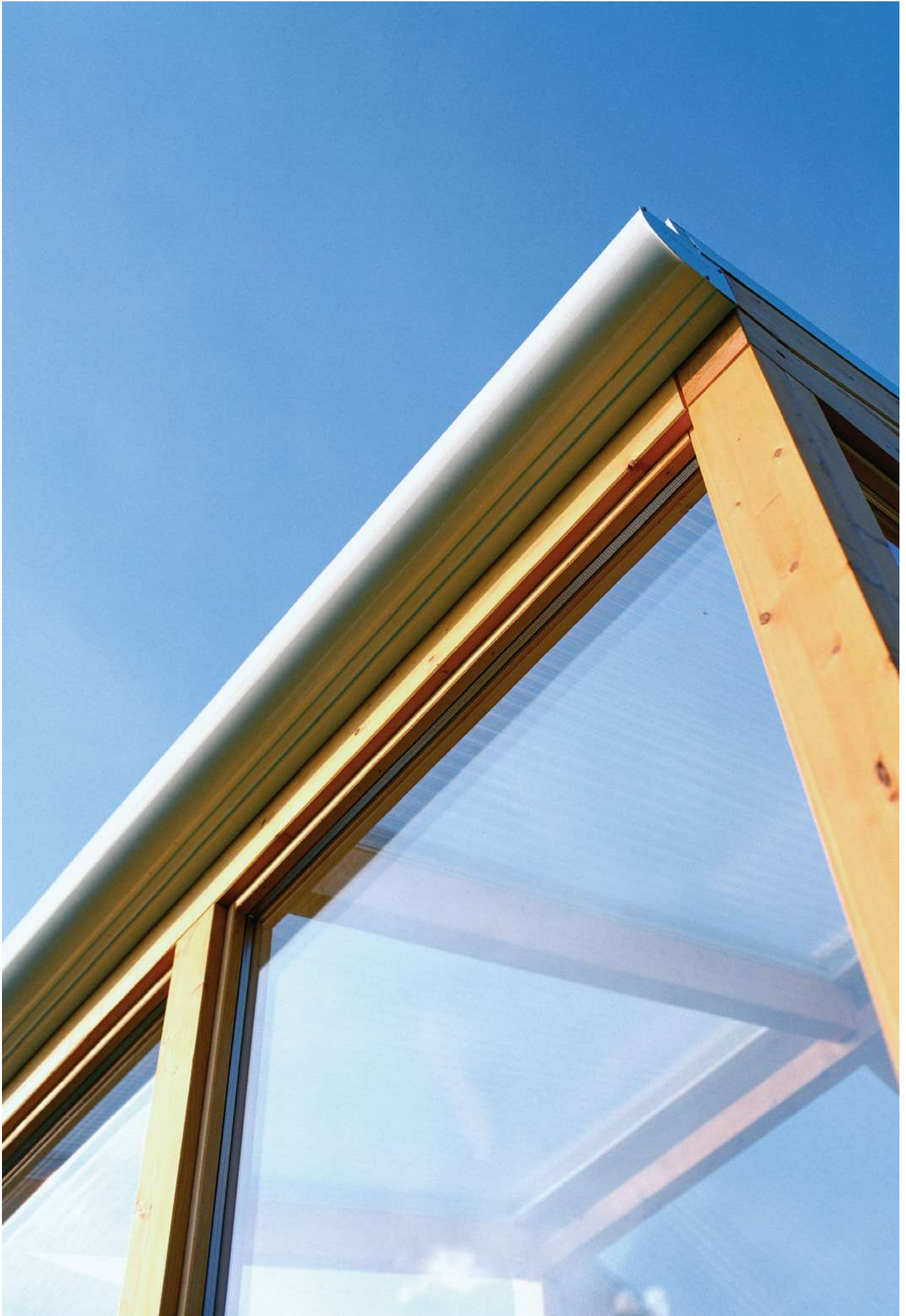

# Installation

The pictures show typical glazing systems.

Whichever systems are chosen, take care to use only clamping bars, seals and other auxiliary agents and installation materials that are compatible with PLEXIGLAS®. This excludes plas-

ticized PVC, paint solvents, degreasing agents and other corrosive media.

In case of doubt, or to obtain information on the compatibility and function of different glazing systems, please contact your PLEXIGLAS® distributor.



## Length of the glazing bar

The glazing bar must be at least the same length as the purlin.



## Length of the glazing bar

The leg length (a) of the Aluminium Terminal Angle is usually added to the length of the purlin or glazing bar. This angle prevents the sheet from slipping.

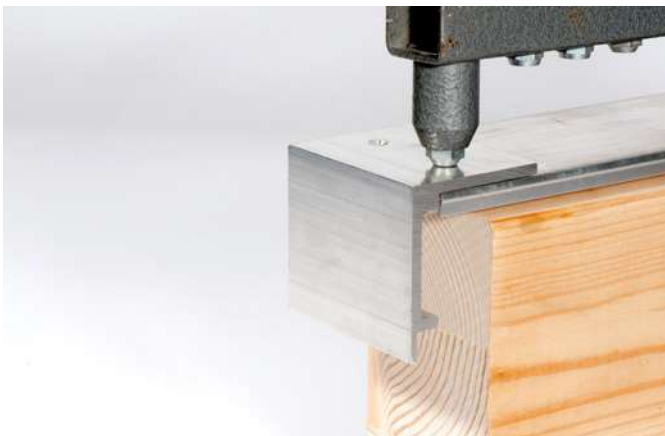

## Fastening the terminal angle

The Aluminium Terminal Angle is fastened by means of rivets or screws before installing the glazing bar.



### Installing the glazing bars

The base sections should be fastened to the wooden or metal purlins by means of screws spaced approx. 50 cm apart. Suitable edge sections should be used for the roof edges.



top



bottom

### Closing the open ends of the multi-skin sheets

If the open ends of the multi-skin sheets are not protected on delivery by suitable end closure sections that prevent dirt, water and insects etc. from entering the cavities, they must be sealed before installation. A simple but very important rule applies for closing the open ends of the sheets: they should be sealed as tightly as possible at the top (Aluminium End Closure Section + adhesive aluminium tape) and as tightly as necessary at the bottom (only Aluminium End Closure Section).



### Walking on the roof

It is often unavoidable to walk on the roof when installing the sheets and glazing bars.

Roofing with PLEXIGLAS® multi-skin sheets should only be walked over by means of crawling boards that are at least 50cm wide. These protect the sheet and comply with occupational safety standards. Placing a non-slip blanket or such between the PLEXIGLAS® sheet and the board protects the sheet from scratching.



### **Installing the glazing bars**

Suitable PVC edge sections or special base edge sections are used to close off the roof at the sides.



### **Installing the glazing bars**

Depending on the chosen type of glazing system, the base and upper sections are connected using PVC spacer sections or are directly clipped on or screw-fastened. Cover sections, some of them colored, are available to conceal the heads of the screws.



### **Installing the glazing bars**

The upper sections are fastened by means of suitable screws with washer. An aluminium cover section can be clipped on if desired.



### **Installing the glazing bars**

Suitable screw-on wall connecting systems are available for roofs that touch the walls of the house. The sealing strips of these systems are incised at the points where they meet the glazing bars.





### Installing the glazing bars

The wall connecting systems can be sealed at the wall using permanently flexible rubber. If butt joints and corners of glazing bars need to be sealed, e.g. using suitable silicone rubber, the latter must be compatible with PLEXIGLAS®. No vapors must be allowed to enter the sheet cavities.

PLEXIGLAS® distributors offer suitable sealing compounds.



### Removing the masking film

The masking film is removed when all the PLEXIGLAS® multi-skin sheets have been installed.



### Activating the AAA and NO DROP layers

The functional layer of PLEXIGLAS® multi-skin sheets with an AAA or NO DROP coating needs to be activated. This is done by rain, but it is better to wash down the sheets straight after installation (e.g. using high-pressure cleaning equipment with a wide spray nozzle).

# Cleaning/Material behavior in use

A PLEXIGLAS® roof offers its owner unalloyed pleasure. To make sure it stays that way, it is important to know a few things about the material's properties.

Always make sure to use only cleaning agents that are compatible with PLEXIGLAS®

(i.e. no strong industrial cleaning agents, insecticides, solvents or other corrosive agents).

In case of doubt or to receive information on the compatibility and function of different cleaning agents, please ask your PLEXIGLAS® distributor.



## Cleaning

There is no need to clean the outside of the sheet, given adequate roof pitch and in vertical glazing. The rain will wash off any soiling. Should cleaning be necessary, use a garden hose or clear, warm water with a little added household dishwashing liquid. Do not use abrasive cleaning agents. Only use cleaning and auxiliary agents that are compatible with PLEXIGLAS®.



### **Crackling noises**

Any crackling noises are due to physical, temperature-related expansion of the PLEXIGLAS® sheets. They are not a sign that the sheets have been damaged, but show that the sheet material is expanding in the normal way. This expansion has no effect on the functionality of the sheets, glazing bars or screw fastenings. In many cases, the loadbearing supporting structure made of wood or metal causes expansion noises, which the PLEXIGLAS® roof amplifies like a drumhead. These noises are significantly reduced by installing the sheets in rubber gaskets on all sides.



### **Condensation**

Condensation is a natural phenomenon and is usually restricted to the eaves area.

PLEXIGLAS® is slightly permeable to gas and vapor. For these reasons it is practically impossible to seal the sheet cavities hermetically in the long term. Damp air that enters the sheets may therefore cause condensation and fogging of the cavities under certain weather conditions. This does not diminish the material properties or function of the sheets. If suitable vent holes are provided at the lower sheet ends, condensate can drain off or evaporate.

# Instructions for installing PLEXIGLAS® corrugated sheets

## Planning

Careful planning and choosing the right tools, combined with correct storage and fabrication of PLEXIGLAS®, guarantee that you will be satisfied with the overall structure for a long time to come.



### Tools/auxiliary agents

The following tools/auxiliary agents are required for installing PLEXIGLAS® corrugated sheets, depending on the type of project.

- Paint brushes
- White, light-resistant emulsion paint
- Tape measure
- Electric drill
- Conical drill/plastics drill
- Screws for fastening the corrugated sheets
- Circular handsaw with multi-tooth saw blade

And/or

- Jigsaw with saw blade for 'unplasticized plastics'
- Crawling boards or other support to prevent scratching



### Storage

If PLEXIGLAS® corrugated sheets are not to be installed straight away, they should be stored correctly until used.

If possible, please store the sheets indoors. The PLEXIGLAS® corrugated sheets are protected against sunlight and moisture during transport by white PE sheeting. Please leave this outer packaging in place if the sheets are stored outdoors.

The same applies to opened palettes.

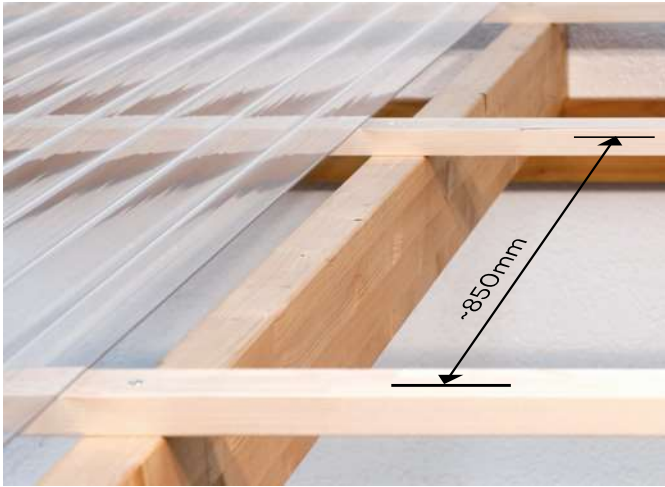

### Support spacing

PLEXIGLAS® corrugated sheets are installed on statically supporting structures (purlins or crossbars) that are positioned at right angles to the direction of slope or water flow. Given average snow loads and wind pressure, it is sufficient to install the crossbars or purlins at spaces of approx. 850 mm. The spacing should be reduced if greater loads apply.

You can find information on this subject in the product descriptions of the PLEXIGLAS® corrugated sheets at [www.plexiglas.net](http://www.plexiglas.net).

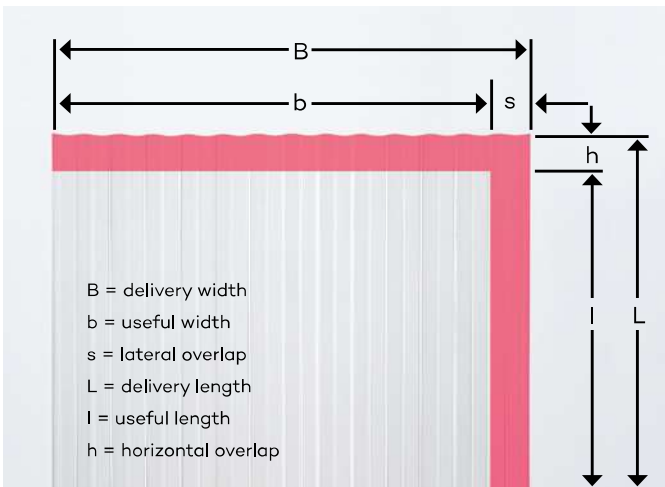

### Installation

Corrugated sheets are typically installed so as to overlap. This means that the surface of the corrugated sheets is somewhat larger than the actual roof surface. The useful width (b) is less than the sheet width (B). This is due to the complete or half overlap of the lateral crest of corrugation (s).

We recommend that the installed sheets should not measure much more than 4,000 mm in length. In very long roofs, corrugated sheets should be installed with horizontal overlap (h).

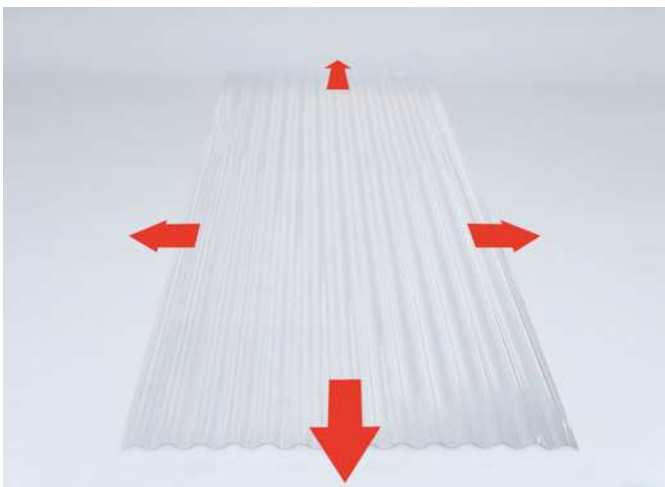

### Allowance for expansion

PLEXIGLAS® corrugated sheets expand due to heat and moisture. An allowance of approx. 6 mm/m sheet length and width therefore has to be made for expansion. The required distance from walls owing to the allowance for expansion can be bridged using suitable wall connecting systems, for example.

Suppliers of PLEXIGLAS® corrugated sheets will be pleased to provide information in this context.



### Installation direction

For outside applications, PLEXIGLAS® corrugated sheets with a textured surface (Honeycomb, C texture) should be installed with the textured side facing downwards. The smooth surface keeps the sheet clean longer and is much easier to clean.

# Supporting structure

The wooden or metal supporting structure bears the main brunt of snow loads and wind pressure. It must therefore be sufficiently stable and safe. It is important to select the right type of foundations, depending on the building project.



## Roof pitch

PLEXIGLAS® corrugated sheets are to be installed at a roof pitch of at least 5° (= 90 mm/m) to ensure that rainwater runs off. The steeper the slope, the better dirt is washed off by the rain.



## Material/Preventing heat buildup

The supporting structure must be non-warping and consist of laminated timber beams or metal. Dark-colored surfaces heat up to a greater extent and faster than light-colored surfaces.

It is therefore very important to provide all structural surfaces facing the sheets with a durable white or reflective coating (e.g. light-resistant emulsion paint). The coating of the supporting structure must be allowed to dry properly before installing the sheets.

# Machining

The ease and almost unlimited variety of options with which PLEXIGLAS® can be machined are among its main advantages as compared with many other transparent materials. Using the correct tools is essential for successful work.

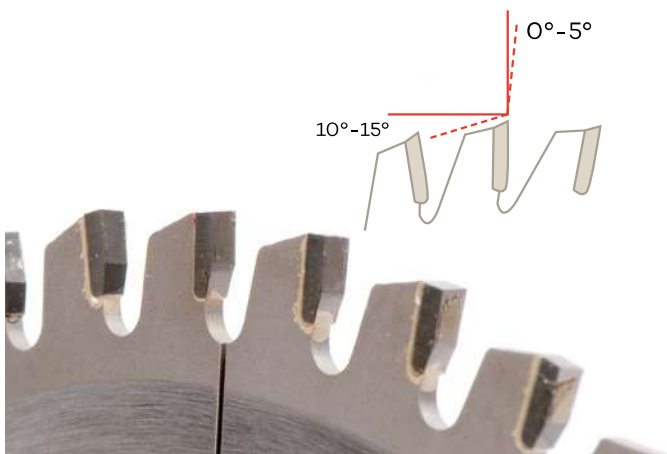

## Cutting to size

High-speed circular (hand)saws with unset, multi-tooth carbide-tipped blades are most suitable for cutting PLEXIGLAS® corrugated sheets to size.

We advise against the use of cutting disks to avoid possible damage to the sheets (subsequent stress cracking).



## Marking

The best way to mark PLEXIGLAS® corrugated sheets is by using a water-soluble pen. The corrugated sheets should be secured against flutter. It is best to work with a stop, such as a wooden bar, to prevent the saw from tilting and causing an accident or chipping the edge of the corrugated sheet.



## Drilling

Drilling should be performed using a conical drill that provides drill holes of 10, 12 and 13 mm in diameter. Corrugated sheets that overlap horizontally are drilled together. The holes in the lower sheet may need to be drilled open a few more millimeters (after lifting off the topmost sheet) so that the two sheets can expand against each other. Make sure the edges of the drill holes are smooth and clean.

# Installation

The pictures show typical glazing systems. Whichever systems are chosen, take care to use only fastening devices, seals and other auxiliary agents and installation materials that are compatible with PLEXIGLAS®. This excludes plasticized PVC, paint solvents, degreasing agents and other corrosive media.

In case of doubt, or to obtain information on the compatibility and function of different glazing systems, please contact your PLEXIGLAS® distributor.



## Walking on the roof

Roofing with PLEXIGLAS® corrugated sheets should only be walked over by means of crawling boards that are at least 50 cm wide. These protect the sheets and comply with occupational safety standards.

Placing a non-slip blanket or such between the PLEXIGLAS® sheet and the board protects the sheet from scratching.

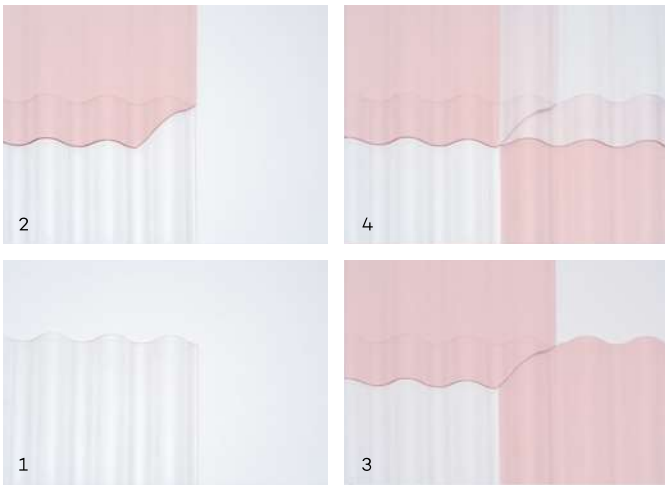

## Installing longer roofs with cut-out corners

If two or more sheets have to be installed with a longitudinal overlap, for example on very long roofs, the sheet corners should be cut at the points where there is a multiple overlap so that they can lie next to each other.

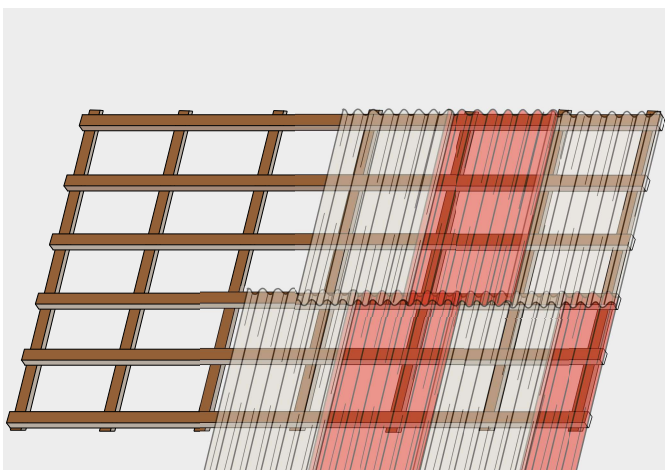

## Installing longer roofs with a staggered sheet arrangement

PLEXIGLAS® corrugated sheets can be installed in a staggered arrangement to avoid cutting out corners or creating a four-fold overlap. To do this, start for example in the bottom row with a sheet cut in half widthwise and with a whole sheet in the upper row.



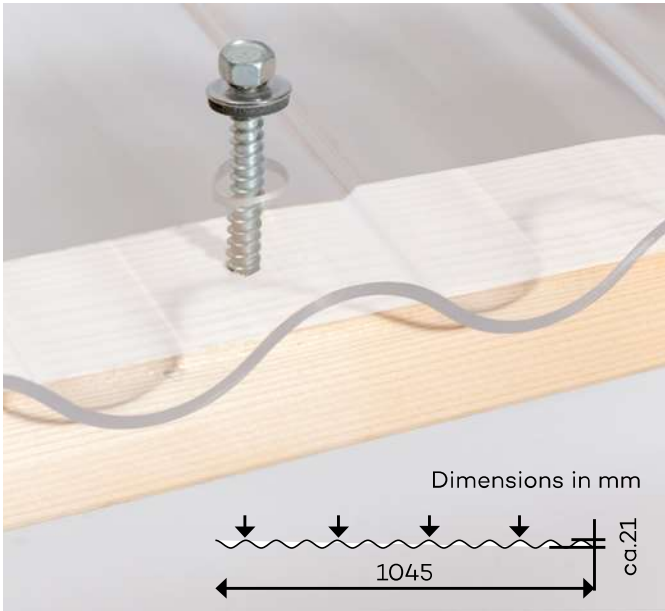

### Fastening points

The PLEXIGLAS® corrugated sheets should always be fastened pointwise to the supporting structure. On roofs, fastening is always performed at the crest of the corrugation.

When doing so, make sure to allow for expansion of the sheets, i.e. provide adequately dimensioned drill holes.

The figure shows an example of fastening points for PLEXIGLAS® WP 76/18.



### Fastening elements, screw fastening

The sheets are fastened to the supporting structure using façade screws, J-bolts etc., ideally in combination with calottes.

The most common way to fasten corrugated sheets is by means of special commercially available screws (6.5 mm Ø) for wood or metal (in some cases self-tapping), complete with an adequately sized washer. Owing to the superior material thickness and rigidity of PLEXIGLAS® corrugated sheets, there is no need to place shims beneath the crest of the corrugation (such as are required for thin or soft corrugated plastic sheets).

Only gaskets compatible with PLEXIGLAS® may be used for installation (on no account use unplasticized PVC!). This also applies to fastening elements etc. For further information, go to [www.plexiglas.de](http://www.plexiglas.de).



### **Fastening elements, calotte**

An aluminium calotte, e.g. 76/18 with flexible coating, must also be placed beneath the head of the screw. This calotte, whose shape is adapted to the individual corrugated sheet profile, seals the drill hole below and evenly distributes the screw pressure.

Suppliers of PLEXIGLAS® corrugated sheets will be pleased to inform you about screws and calottes.



### **Fastening elements, J-bolts**

Other items suitable for fastening the corrugated sheets, particularly to tubular purlins, are commercially available J-bolts with a 6 mm thread and screw at the upper end, since these allow the plastic to move in an ideal manner. Screws should only be tightened until initial resistance is encountered. J-bolts can also be used in conjunction with aluminium calottes.



### **Sealing caps**

PE sealing caps are suitable for use with J-bolts.

The sealing caps should be compatible with PLEXIGLAS®, seal the drill hole against water from the outside, distribute the bolt pressure and act as a spacer between the bolt and the edge of the drill hole. The gaskets available on the market for installing corrugated sheets made from other plastics, fiber-reinforced concrete, metal etc. can only be used for PLEXIGLAS® corrugated sheets if they meet the above requirements (e.g. no gaskets made of plasticized PVC).



# Cleaning/Material behavior in use

A PLEXIGLAS® roof offers its owner unalloyed pleasure. To make sure it stays that way, it is important to know a few things about the material's properties.

Always make sure to use only cleaning agents that are compatible with PLEXIGLAS®

(i.e. no strong industrial cleaning agents, insecticides, solvents or other corrosive agents).

In case of doubt or to receive information on the compatibility and function of different cleaning agents, please ask your PLEXIGLAS® supplier.



## Cleaning

There is no need to clean the outside of the sheet, given adequate roof pitch and in vertical glazing. The rain will wash off any soiling. Should cleaning be necessary, use a garden hose or clear, warm water with a little added household dishwashing liquid. Do not use abrasive cleaning agents.

Only use cleaning and auxiliary agents that are compatible with PLEXIGLAS®.



## Crackling noises

Any crackling noises are due to physical, temperature-related expansion of the PLEXIGLAS® sheets. They are not a sign that the sheets have been damaged, but show that the sheet material is expanding in the normal way. This expansion has no effect on the functionality of the sheets, glazing bars or screw fastenings. In many cases, the loadbearing supporting structure made of wood or metal causes expansion noises, which the PLEXIGLAS® roof amplifies like a drumhead.

These noises can be significantly reduced by making sure not to fasten the screws on the corrugated sheet roof too tightly, and possibly by placing an intermediate layer, e.g. white Teflon strips, between the purlins and the sheets.



# Instructions for Installing PLEXIGLAS® solid sheets

## Planning

Careful planning and choosing the right tools, combined with correct storage and fabrication of PLEXIGLAS®, guarantees that you will be satisfied with the overall structure for a long time to come.



### Tools/auxiliary agents

The following tools/auxiliary agents are required for installing PLEXIGLAS® solid sheets, depending on the type of project.

- Waterproof marker
- Medium to fine machine file
- Scraper
- Spray bottle
- Step drill
- Conical drill
- Countersink
- Metal drill with correct grinding for acrylic (point angle 60° to 90°)
- Contour cutter with stop ring
- Jigsaw blade with straight teeth and tooth pitch of 2.5 mm
- Circular saw blade with straight teeth (ideally trapezoidal flat teeth) and tooth pitch of approx. 13 mm



### Storage

If PLEXIGLAS® solid sheets are not to be installed straight away, they should be stored correctly until used.

If possible, please store the sheets indoors. The PLEXIGLAS® solid sheets are protected against soiling and moisture during transport by PE sheeting. Please leave this sheeting in place if the sheets are stored outdoors.

The same applies to opened palettes.

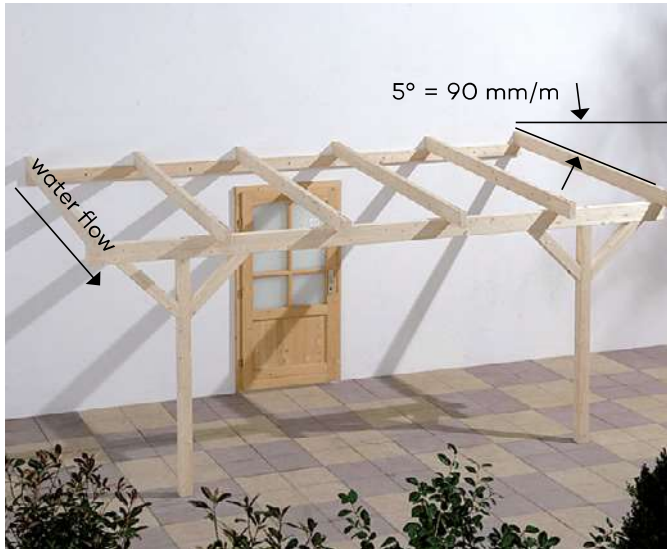

### Roof pitch

Roofs glazed with PLEXIGLAS® solid sheets should have a roof pitch of at least 5° (= 90 mm/m) to allow rainwater to flow off safely. As a general rule, the greater the roof pitch, the better the roof can be cleaned by the rain.

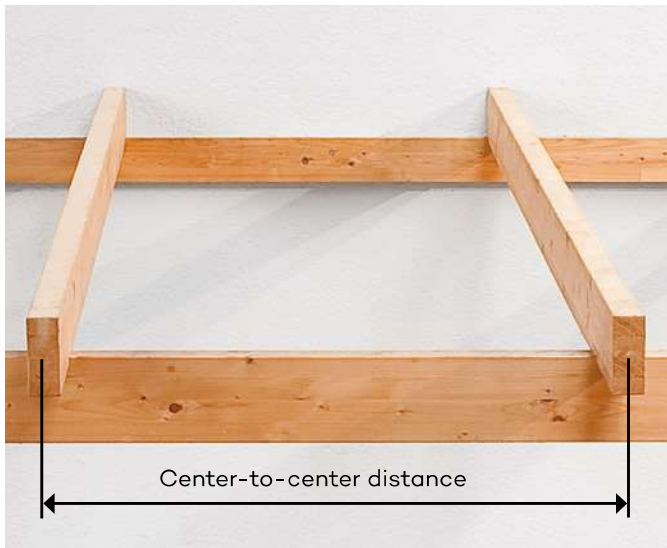

### Center-to-center distance

The center-to-center distance (from the center of one support to the center of the next) provides sufficient allowance for widthwise expansion of PLEXIGLAS® solid sheets. It depends on the chosen glazing system and can be ascertained from PLEXIGLAS® suppliers. The center-to-center distance is calculated as the sheet width in mm + 6 mm for expansion +d of the fastening system. Given average snow loads and wind pressures of approx. 680 n/m<sup>2</sup>, we recommend using a sheet thickness of at least 12 mm for a sheet width of approx. 1,000 mm. To reduce the amount of scrap, please bear in mind the standard sheet size of 3,050 x 2,030 mm.

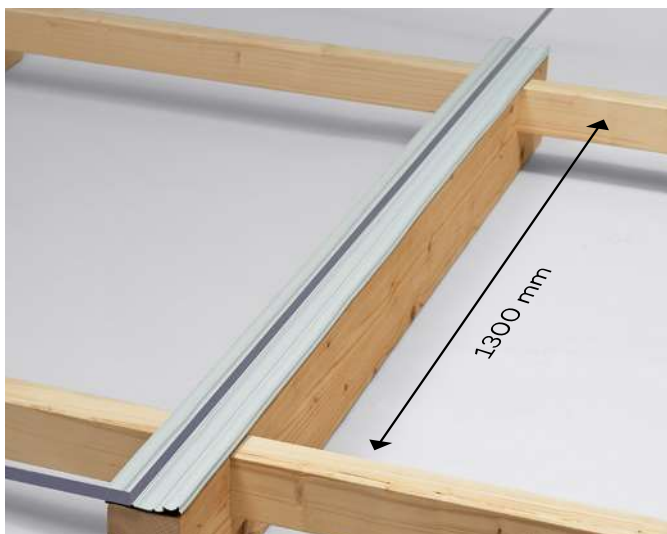

### Crosswise supports

PLEXIGLAS® solid sheets with a thickness of 8 to 10 mm are installed on loadbearing supports on all four sides.

Given average snow loads and wind pressures of approx. 680 n/m<sup>2</sup>, crosswise support spacing of approx. 1,300 mm is sufficient. The spacing must be reduced correspondingly for greater loads.



### **Material/Preventing heat buildup**

The supporting structure should be non-warping and consist of laminated timber beams or metal. Dark surfaces heat up to a greater extent and faster than light-colored surfaces.

It is therefore very important to provide all structural surfaces facing the sheets with a durable white or reflective coating (e.g. light-resistant emulsion paint).

The coating on the supporting structure must be allowed to dry properly before installing the sheets.



### **Rebate depth**

Owing to the linear expansion of the PLEXIGLAS® sheet, the rebate depth should be between 15 and 20 mm.



### **Expansion**

An allowance "a" must be additionally made for sheet expansion. Value "a" depends on the sheet dimensions and corresponds to half of the overall allowance for expansion.

The allowance for expansion is 6 mm per meter.



# Machining

The ease and almost unlimited variety of options with which PLEXIGLAS® can be machined are among its main advantages as compared with many other transparent materials. Using the correct tools is essential for successful work.



## Cutting to size

High-speed circular (hand)saws with unset, multi-tooth carbide-tipped blades are most suitable for cutting PLEXIGLAS® solid sheets to size. The solid sheets should be secured against flutter. It is best to work with a stop, such as a wooden bar, to prevent the saw from tilting and causing an accident or damaging the cut edge of the sheet.



## Corner cut-outs

If a corner needs to be cut out (e.g. to accommodate pipes, vents etc.), a hole should be drilled in the sheet at the point where the cuts intersect. To cut out corners, drill the hole first at the corner and then cut to it from the sheet edge, using a coarse-toothed jig saw without pendulum stroke. Marking is best done on the masking film, which should be left on the sheet while working on it and until it has been installed.



## Drilling

If drill holes are required, e.g. for cutting out corners, use twist drills with special bits for acrylic (which “scrape rather than cut”), conical or step drills.

# Installation

The pictures show typical glazing systems.

Whichever systems are chosen, take care to use only clamping bars, seals and other auxiliary agents and installation materials that are compatible with PLEXIGLAS®. This excludes plasticized

PVC, paint solvents, degreasing agents and other corrosive media.

In case of doubt, or to obtain information on the compatibility and function of different glazing systems, please contact your PLEXIGLAS® distributor.

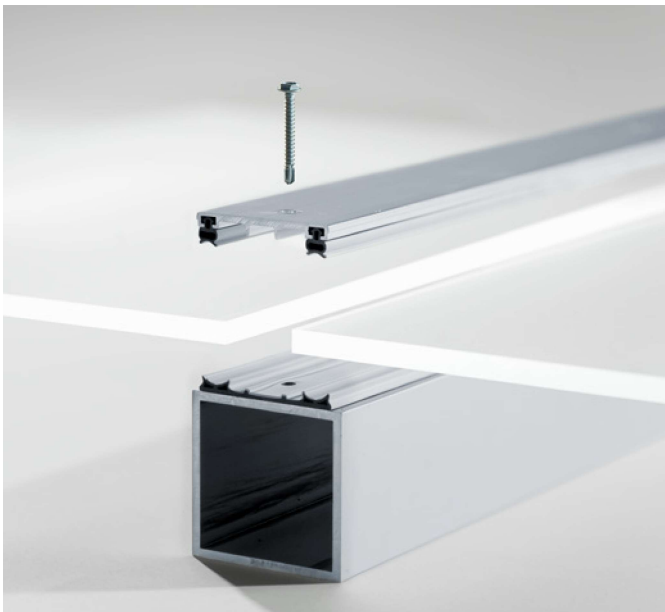

Preference should always be given to linear fastening because this offers better load distribution and makes it possible to use thinner sheets.

PLEXIGLAS® is sensitive to certain sealing materials. Seals should therefore always be examined for their compatibility with PLEXIGLAS®.

The following are usually suitable:

- APTK (EPDM)
- Polychloroprene
- PE, PTFE, TPE and silicone rubber



## Allowance for expansion

PLEXIGLAS® solid sheets expand due to heat and moisture. A general allowance is therefore to be made of approx. 6 mm/m of sheet length and width. The required gap between sheet and wall to make this allowance can be bridged for example by means of suitable wall connecting systems.





### **Length of the glazing bar**

The glazing bar must be at least the same length as the purlin.

The leg length of the Aluminium Terminal Angle is usually added to the length of the purlin or glazing bar. This angle prevents the sheet from slipping.

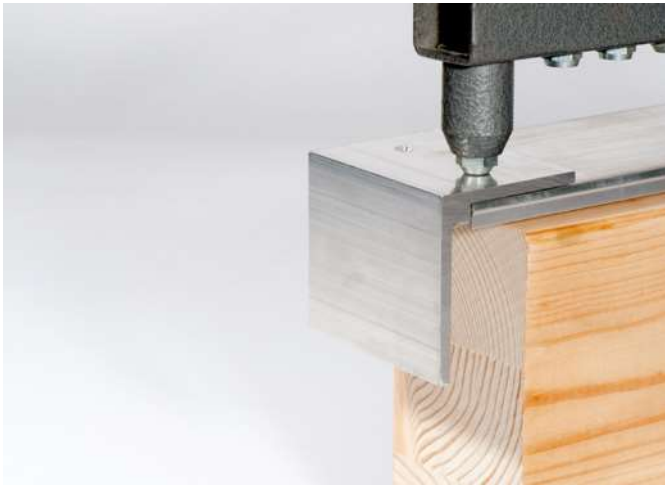

### **Fastening the terminal angle**

The Aluminium Terminal Angle is fastened by means of rivets or screws before installing the glazing bar.



### **Installing the glazing bars**

The upper sections of the profiles should be fastened to the wooden or metal purlins by means of screws spaced approx. 330 mm apart.



### Installing the glazing bars

Suitable PVC edge sections or special base edge sections or aluminium sections are used to close off the roof at the sides.

The upper sections of the glazing bars are fastened by means of suitable screws with washer.



optimized clamping system



excessive clamping pressure

### Contact pressure

This pressure must be calculated in such a way that adequate tightness is achieved while the sheets can still slide in response to linear thermal expansion. If the contact pressure is too high, this may be detrimental to the system. Since the pressure mainly affects the weakest link in the fastening system, the elastic seal becomes excessively compressed.



### Walking on the roof

It is often unavoidable to walk on the roof when installing the sheets and glazing bars.

Roofing with PLEXIGLAS® solid sheets should only be walked over by means of crawling boards that are at least 50 cm wide. These protect the sheet and comply with occupational safety standards. Placing a non-slip blanket or such between the PLEXIGLAS® sheet and the board protects the sheet from scratching.



### Installing the glazing bars

Suitable screw-on wall connecting systems are available for roofs that touch the walls of the house. The sealing strips of these systems are incised at the points where they meet the glazing bars.



### Installing the glazing bars

The wall connecting systems can be sealed at the wall using permanently flexible rubber. If butt joints and corners of glazing bars need to be sealed, e.g. using suitable silicone rubber, the latter must be compatible with PLEXIGLAS®. PLEXIGLAS® distributors offer suitable sealing compounds.



### Removing the masking film

The masking film is removed when all the PLEXIGLAS® solid sheets have been installed.



### Barrel vaults

On the supporting structure, the cut-to-size sheets are cold-curved over correspondingly formed (metal) hoops and fastened with glazing bars (e.g. screwed down between the sheets) over the arc length. The same system is used to fasten the lower ends to the longitudinal gutter sections. Compatible seals are used in between the clamping system and the sheet.

Cold curving generates stress within the material that has to be limited. Therefore it is essential to observe the minimum cold-bending radius specified for a given sheet material and thickness.

### Minimum cold-bending radius

Minimum cold-bending radius in mm per thickness in mm							
	Equation	3	4	5	6	8	10
PLEXIGLAS® GS und XT	$r_{\min} = 330 \times \text{thickness}$	990	1320	1650	1980	2640	3300
PLEXIGLAS® Resist 65	$r_{\min} = 250 \times \text{thickness}$	750	1000	1250	1500	2000	2500

### Sheet thickness for barrel vaults

The required sheet thickness can be taken from the graphic below. The values were calculated with a safety factor of 1.5 against buckling, according to E.R. Berger: "An approximation formula for the buckling stress on a concentrically compressed arched

shell", Beton- und Stahlbau 48 (1953), page 288. These data are meant as a guideline for our customers. Where proof is required, people carrying out projects should entrust a static engineer with the calculations.

### Sheet thickness in mm for barrel vaults with a hoop spacing of 1,000 mm and a wind pressure/snow load (radial pressure) of 750 N/m<sup>2</sup>

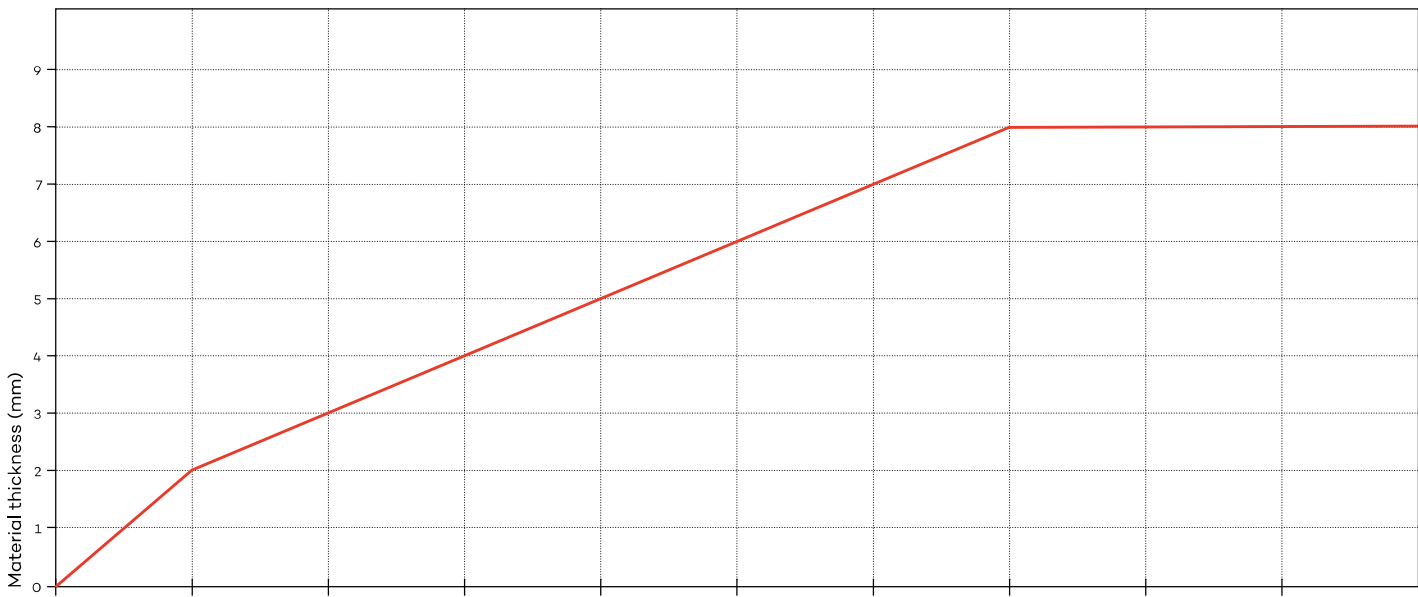

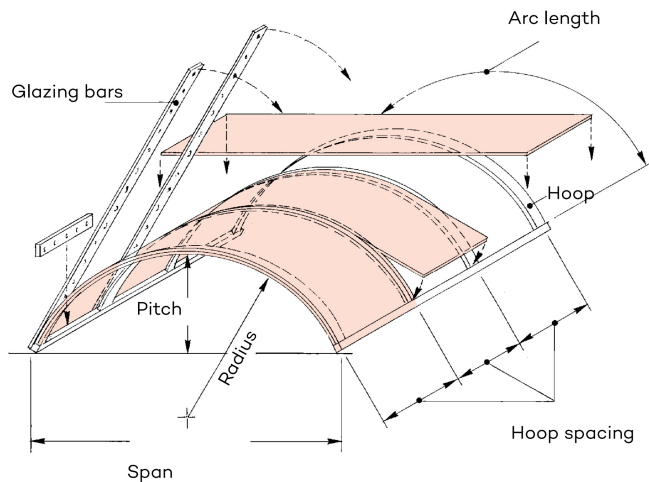

### Optimal hoop spacing

We recommend a hoop spacing of approx. 1,000 mm. To produce as little scrap as possible, please bear in mind the standard sheet size of 3,050 x 2,030 mm.

In the case of barrel vaults with greater arc lengths than the available sheet lengths, the arc has to be divided up (at the ridge or several times) by putting several cut-to-size sheets together with transverse joints. The same clamping systems as for the curved hoops are to be used for the transverse joints and due allowance is to be made for sheet expansion.



### Canopy systems

If a pointwise fastening technique is used, it must be appropriate for the chosen material. This variant looks particularly elegant if the sheet edges are polished. The drill hole in the sheet must be much larger than the screw thread. Protect the sheet wall inside the drill hole with a compatible sleeve (e.g. polyethylene) around the thread. Use large washers (at least 60 mm in diameter) with the screws and compatible elastic seals (e.g. EPDM rubber).

Tighten the screws only to such an extent that the sheets are still able to move.

- The maximum projection of the canopy should be 1,200 mm.
- The spacing between drill hole and sheet edge should be approx. 150 mm.
- Fastening points should be spaced at about 330 mm.
- The roof pitch should be at least 5–10° (= 90–180 mm/m).
- Sheet thickness from 12 mm

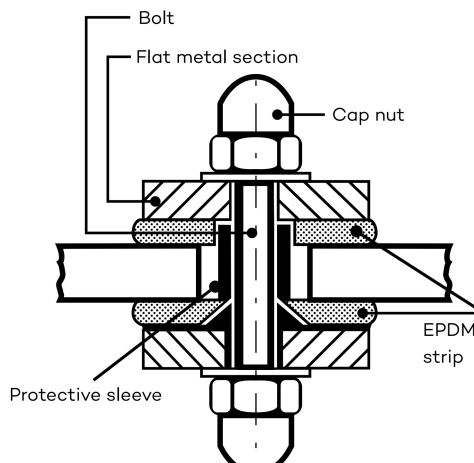



# Cleaning

A roof glazed with PLEXIGLAS® solid sheets offers its owner unalloyed pleasure. To make sure it stays that way, it is important to know a few things about the material's properties.

Always make sure to use only cleaning agents that are compatible with PLEXIGLAS® (i.e. no strong industrial cleaning agents, insecticides, solvents or other corrosive agents).



## Cleaning

There is no need to clean the outside of the sheet, given adequate roof pitch and vertical glazing. The rain will wash off any soiling. Should cleaning be necessary, use a garden hose or clear, warm water with a little added household dishwashing liquid. Do not use abrasive cleaning agents. Only use cleaning and auxiliary agents that are compatible with PLEXIGLAS®.

Suitable cleaning agents are

- lukewarm water with a little added dishwashing liquid
- concentrated vinegar diluted with water
- isopropyl alcohol (2-propanol)
- pure naphtha
- a soft, damp viscose sponge
- a soft, damp, non-linting cloth
- a sponge cloth
- chamois leather
- glove-lining fabric
- cotton dishcloth
- shower cabin squeegee with soft rubber blade
- damp microfiber polishing cloth (e.g. Vileda® Microclean)



## SUSTAINABILITY

**The Sustainable Development Goals (SDG), adopted by the United Nations in 2016, all have one goal: by 2030, all inhabitants of planet Earth should be able to live in dignity.**

To this end, the United Nations has formulated 17 goals to support global sustainability efforts. The SDGs are our compass in aligning our sustainability-strategy, creating innovations and identifying new business opportunities and take advantage of them.

Products and solutions from Röhms make a measurable contribution to achieving these goals. This is how we assume responsibility.



**Röhms GmbH**  
Acrylic Products

Riedbahnstraße 70  
64331 Weiterstadt  
Germany

**[www.plexiglas.de](http://www.plexiglas.de)**  
**[www.roehm.com](http://www.roehm.com)**

® = registered trademark

PLEXIGLAS is a registered trademark of Röhms GmbH, Darmstadt, Germany.

Certified to DIN EN ISO 9001 (Quality) and DIN EN ISO 14001 (Environment)

This information and all further technical advice is based on our present knowledge and experience. However, it implies no liability or other legal responsibility on our part, including with regard to existing third party intellectual property rights, especially patent rights. In particular, no warranty, whether express or implied, or guarantee of product properties in the legal sense is intended or implied. We reserve the right to make any changes according to technological progress or further developments. The customer is not released from the obligation to conduct careful inspection and testing of incoming goods. Performance of the product described herein should be verified by testing, which should be carried out only by qualified experts in the sole responsibility of a customer. Reference to trade names used by other companies is neither a recommendation, nor does it imply that similar products could not be used.